

Electronic power supply

EX-170 G/3-US

INSTALLATION AND OPERATION MANUAL

MAN0094/2

Table of contents

GENERAL PURPOSES	
Description	5
Block diagram	6
TECHNICAL SPECIFICATIONS	
<i>Technical specifications*</i>	7
FUNCTIONS AND CONTROLS	
Control devices	8
CONNECTION AND OPERATING INFORMATION	
Receiving the unit	10
Delivery arrangement	10
Storage	10
Removing of package and handling	10
Installation - environment	10
Warnings	11
Feet mounting displacement	11
Preliminary checks	12
Preparing the cables for remote control operation	12
Connecting the input-output cables	13
Connecting the cable for remote control operation	13
DIRECTIONS FOR USE	
Local operation through the front panel controls	14
Switching on	14
Changing the lamp current	14
Switching off	15
Remote operation	16
Switching on	16
Setting the lamp current	17
Changing the lamp current	18
Switching off	18
Overheating protection and alarms	19
Fan replacement	20
TROUBLESHOOTING	
Possible failures	21
TECHNICAL DATA	
Suggested wiring diagram	24
<i>Overall dimensions*</i>	25

* these sections have been modified with respect to the previous issue.

Caution !

You should read this manual before attempting any intervention inside the unit.

The noncompliance with the instructions given in this manual can lead to serious damage to the unit which in this case will invalidate the warranty.

No compensation or indemnity under any kind will be acknowledged for injury or damage due to use or misuse of the product, for poor operation of the appliances connected to IREM product or for immediate or indirect damage caused to the powered equipment.

During the warranty period the replacement of defective parts and maintenance procedures will be exclusively carried out at IREM servicing centre.

Keep this manual along with the unit.

CE declaration is available on request.

This manual aims to give some operating instructions to the user in order to grant a safe and optimal use of the unit.

Keep this manual along with the unit. You should read it carefully both for installation, starting-up and maintenance procedures.

This manual is composed by the following sections:

- . description
(product and application fields)
- . functions and controls
(main characteristics and operation modes)
- . connection and operating information
(directions for connection, start-up and use of the power supply)
- . technical characteristics

Description

This electronic power supply for three phase 208VAC - 50/60Hz input, has been designed to feed from 2000 to 7000W short arc Xenon lamps, meeting all the requirements of lamp manufacturers to ensure correct operation, long life to the lamp, and high reliability.

This compact and lightweight power supply has been designed to meet the requirements of a unit to be installed inside a cabinet.

Its particularly compact design, the advanced circuitry and the displacement of input and output terminal board and the lamp current adjustment make the unit suitable to a wide variety of applications both in vertical and horizontal position and specifically:

- standard film projection
- theatre applications
- architectural applications
- solar simulations.

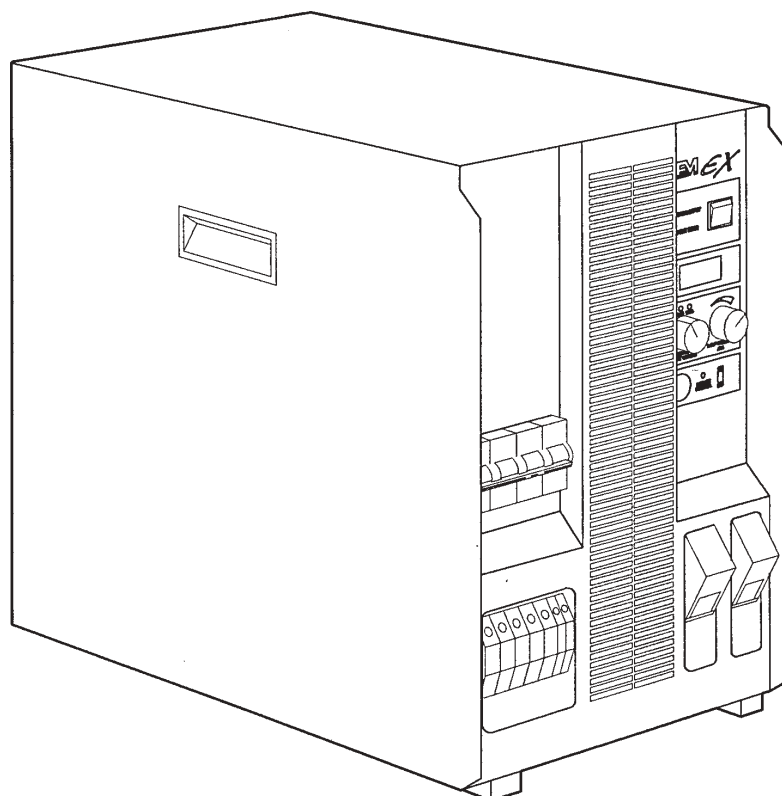

Block diagram

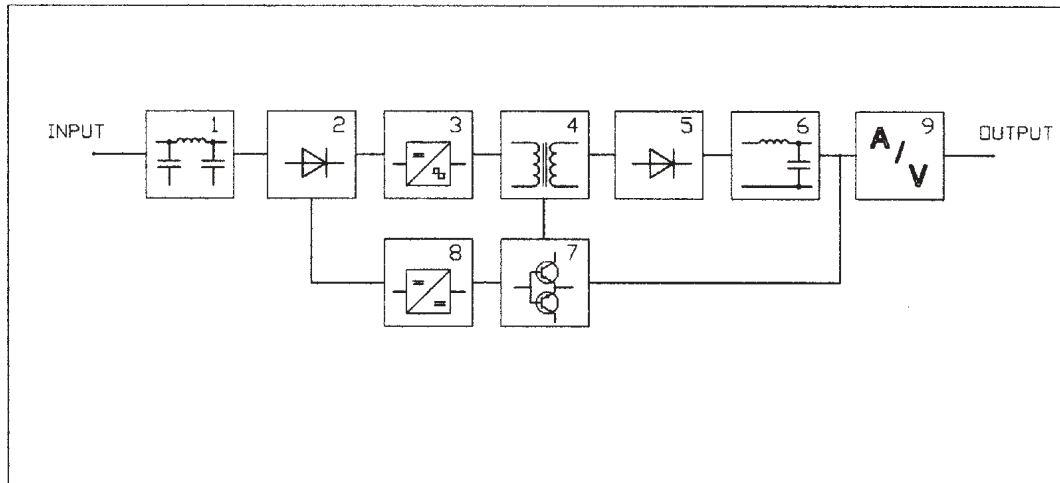

- 1. Input filter board**
Limiting the high frequency interferences (complying with EMI/EEC Standards).
- 2. Diode bridge rectifier**
Converting the alternated voltage from the mains into direct voltage
- 3. Inverter board**
Designed in compliance with IGBT technology, H type full bridge configuration
- 4. High frequency transformer**
Granting the galvanic insulation between input and output
- 5. Output rectifier circuit**
Composed by two fast low noise diodes
- 6. Output filter**
Granting the lamp ripple current value at <1% pk- pk.
- 7. Driving board**
Driving and controlling the unit
- 8. Auxiliary powering board**
- 9. Digital instrumentation**
Displaying output voltage and current values

Technical specifications

Lamp capacity	2000W to 7000W
Nominal input voltage range	187-230V 3ph +N
Input frequency	47-63Hz
Insulation class	CL1
Rated current (max.)	25A
Sinusoidal absorption	not provided
DC output current	60-170A
DC max. voltage	47.5V
No-load voltage	140V
No-load voltage rising time	3 s
Ripple	<1%
Efficiency	0.9
Output overload protection	electronic
Lamp striking	soft-start ignition current
Ventilation	forced
Remote ON/OFF switching	external switch
Igniter insertion control	not provided
Lamp current remote setting	0÷10V control
Setting of lamp current limit	provided
Output current stabilisation	provided
Input circuit breaker	provided
Input extra voltage protection	provided
Lamp ON signalisation	provided
Display signals	mains ON max. temperature ON/OFF remote control lamp max. current setting digital ammeter to read output current digital voltmeter to read output voltage
Safety standards	EN 61204
EMC standards	EN 50081-2 EN 50082-2 EN 50082-1 IEC 61000-6-2 IEC 61000-6-4
Markings	CE, UL (for US market)
Operating temperature	0°C to 45°C
Storage temperature	-20°C to +60°C
Protection degree	IP00
Dimensions	255x475x420h mm
Weight	33 kg

Functions and controls

Control devices

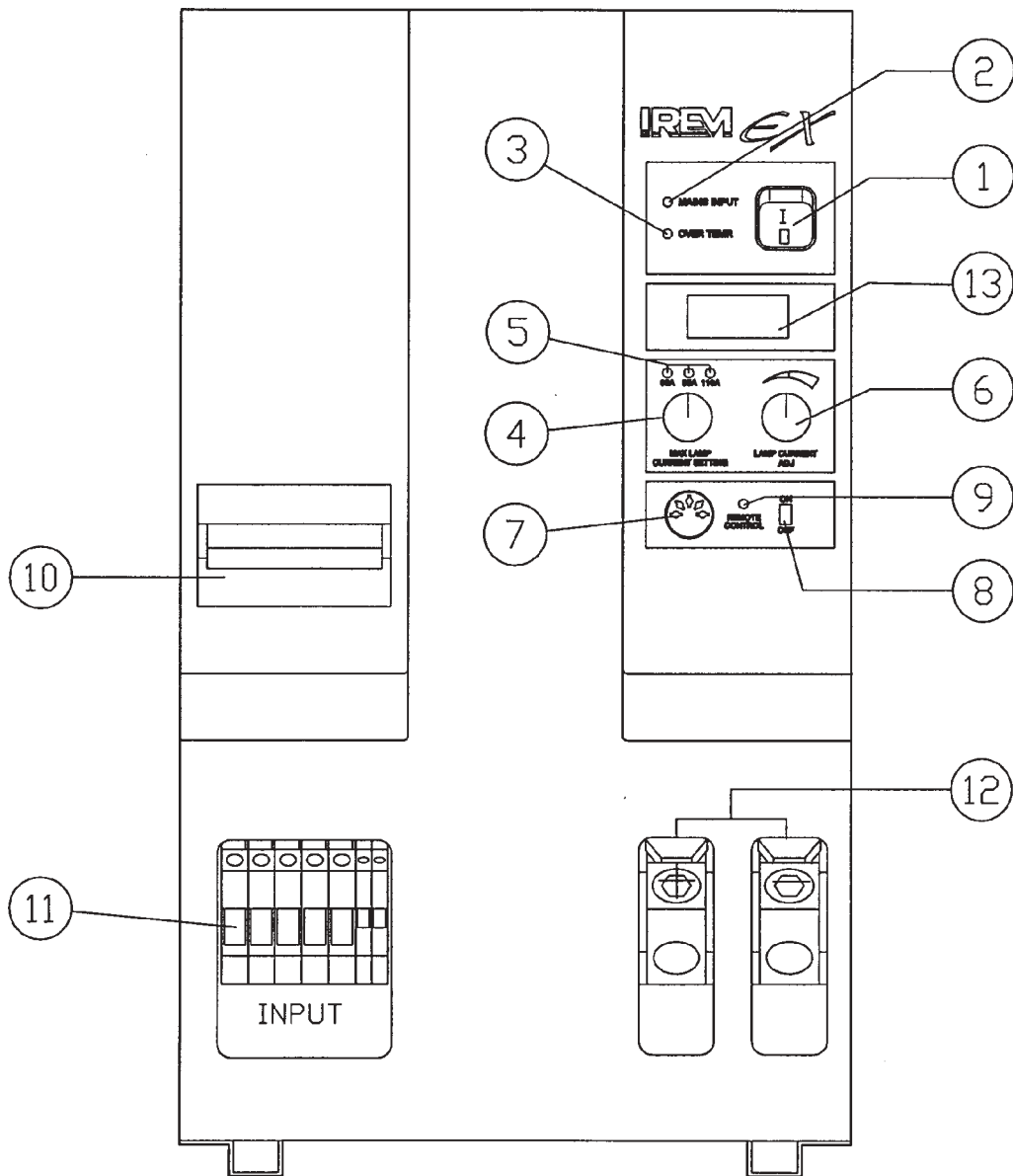

Functions and controls

Control devices

1. **ON/OFF switch**
2. **Mains input LED**
3. **Overtemperature LED**
Lit in case of overheating
4. **Lamp current selector**
Permitting to select the max. powering current in accordance to the lamp capacity
5. **Current LED**
Highlighting the selected current range.
6. **Lamp current potentiometer**
Adjusting the lamp output current
7. **Remote control connector**
Connecting the remote control cable
8. **Remote control selector**
Selecting the ON/OFF switching and the lamp current directly on the unit or remotely by means of the remote control device (0÷10V).
9. **Remote control LED**
Lit when the unit is on remote operation
10. **Input circuit breaker**
11. **Input terminal board**
12. **Output terminal board**
13. **Digital instrumentation**
Displaying lamp current and voltage values

Connection and operating information

Receiving the equipment

After receipt, check that the unit is in good condition. When necessary, contact the forwarding agent.

Delivery arrangement

The supply consists of:
EX170-G/3 electronic power supply
a remote control connector
an installation and operation manual
a warranty card.

Storage

If the unit is stored before installation, check that it is kept dry and cannot come into contact with water in any form. Do not expose the unit to the sun rays or other sources of heat.

Package removing and handling

Remove the packing and keep it in case of future transportation needs.
Carefully lift the unit by means of its handles. Avoid any shock when moving.

Installation - environment

The performance of the **EX170-G/3** electronic power supply is guaranteed for a temperature range variable between 0°C and +45°C. Check that the place where the equipment is to be installed is sufficiently ventilated to prevent the air around the unit from exceeding this limit. Avoid dusty environments. Ensure that the ventilation slots are unobstructed. To prevent blockages caused by excessive temperatures, do not expose the unit to the sun rays or other sources of heat.

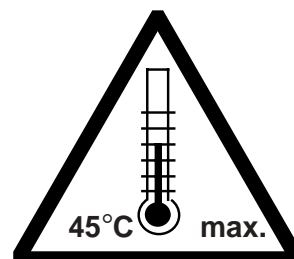

Connection and operating information

Warnings



Caution : dangerous voltages inside the power supply. Disconnect the unit from the mains before checking the internal components. Prevent water, liquids in general and/or foreign objects from getting inside the appliance (do not open the unit, contact IREM servicing centre !).

Installation must only be carried out by trained personnel .



The circuit breaker powering cables are located in the lower part of the unit (see label on the front panel).



If the plant is provided with an earth leakage circuit breaker having a tripping value of 30mA, this breaker could trip when switching on the power supply. This does not normally mean a failure, but is due to the capacitors of the EMI filter. Switch on the earth leakage circuit breaker again to alleviate the problem.

Feet mounting displacement

EX170-G/3 electronic power supply is equipped with two fixing brackets that may be used as an anchoring for the unit (B) or as normal feet when the unit is normally displaced without any fixing (A).

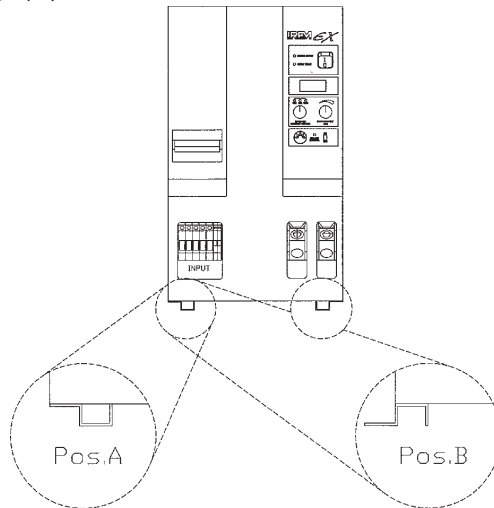

If feet are used as fixing flanges, holes have to be done as per following picture:

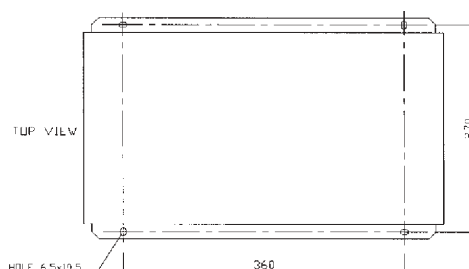

Connection and operating information

Preliminary checks



Important note: the unit may operate without neutral lead. Nevertheless we recommend the neutral connection for a better operation of the input filter board.

Connection must be carried out in compliance with the current safety standards. To ensure a correct operation of the unit, please strictly follow these recommendations:

- the input powering has to be: 208V \pm 10%, 60Hz plus neutral and ground, withstanding a current of 30A per phase
- the earth installation must comply with current standards
- the cables to be connected to the output terminals must have a size suitable to the lamp power.



During connection pay attention to the lamp polarity.

Preparing the cable for remote operation

Make exclusive use of:

- . a shielded cable having 4 poles minimum
- . the connector provided with the unit.

For connection please refer to the wiring diagram and to pin instructions to be found on front panel connector J1/A5.

For switching ON/OFF through remote control make use of a switch with insulated contacts (1A/50V).

The unit is OFF when contacts are open

The unit is ON when contacts are closed.

The setting voltage of remote operation has to be within 0÷10V. Please refer to the setting voltage tables on next pages.

Connection and operating information

Connecting input/output cables

Connect the input cables to the terminal board X1 (11).
Connect the output cables to the terminal board X2 (12).
Pay attention to lamp polarity and terminal identification:

Input terminals

U-V-W: phases
N: neutral (*)
PE: ground

*: if available

Auxiliary terminals

The lamp ON/OFF signalisation is obtained through a N.O. dry relay contact.
Max. withstanding capability: 0.50A / 250Vac



Output terminals

+: positive
--: negative

Connecting the cable for remote operation

Connect the shielded cable to J1 connector (7).

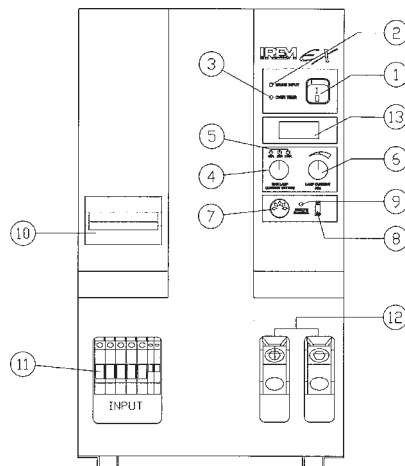

Directions for use

EX170-G/3 electronic power supply may be used either through the front panel controls (local) or through a remote control.

Local operation through front panel controls

Switching on

1. Make sure S1 switch (1) is set to 0 (open).
2. Make sure Q1 circuit breaker (10) is set to OFF (open).
3. Set the max. current selector (4) to the max. lamp capacity.
E.g.: 3000W lamp ----> max. current: 100A ----> selector set to 100A.
4. Turn the current potentiometer P1 (6) completely counter-clockwise.
5. Set the remote control selector (8) to OFF.
6. Check the input voltage is within the limits of the unit data plate (208V \pm 10%).
7. Set Q1 circuit breaker (10) to ON. The LED "mains input" (2) will light up.
8. Be sure the LED no. 5 (lamp max. current) is lit.
9. Set the ON switch (S1 - 1) to 1 position (closed).
10. Be sure the output voltage (to be read on the voltmeter - 13) is 130V \pm 10V
11. Wait 4 s max. then strike the lamp.
12. Gradually increase the output current through the potentiometer (6) till to reach the desired value.
13. Set the current value through the ammeter (13).

Changing the lamp current

To change the lamp current act as follows:

1. Set S1 switch (1) to 0 (open).
2. Set the max. current selector (4) to the new current value. The corresponding LED (no. 5) must light up.
3. Set S1 switch (1) to 1 (closed).
4. Wait 5 s then strike the lamp.
5. Gradually increase the output current through potentiometer (6) to have the desired value.

Directions for use

Local operation through front panel controls

Switching OFF

To switch OFF the unit act as follows:

1. Set S1 switch to 0 (open).
2. Set Q1 circuit breaker (10) to OFF (open).

Remark: if you open the circuit breaker and the lamp is OFF, you have to wait the complete switching off of the power supply (10 s approx.). Then close the circuit breaker again to attempt a new ignition.

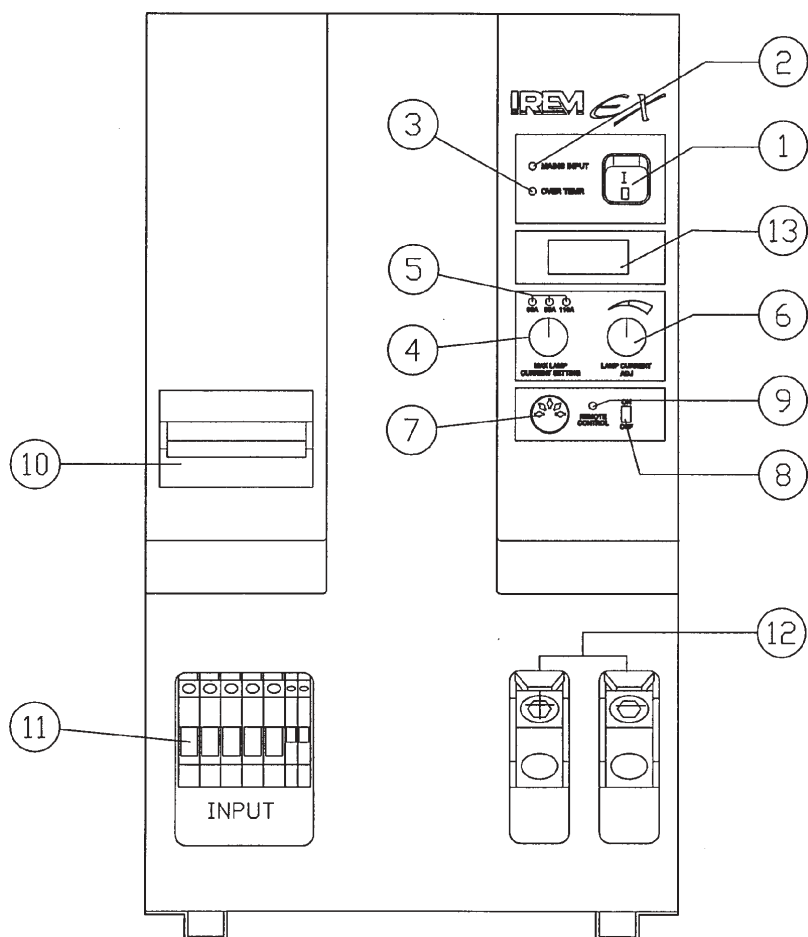

Directions for use

Remote operation

Connect the interface cable to J1 (7) connector.

Switching on

To switch on the unit, please follow the instructions here below:

1. Be sure that the external switch is set to OFF (open)
2. Check that S1 switch (1) is set to 0 (open)
3. Check that Q1 circuit breaker (10) is set to OFF (open)
4. Set the max. current selector (4) to the power corresponding to the lamp max capacity
E.g.: 3000W lamp ----> max current: 100A ----> selector set to 100A.
5. Turn P1 potentiometer (1) for current adjustment completely counter-clockwise.
6. Set the remote control selector (8) to ON.
7. Check that the input voltage of the power supply is within the preset limits as per data plate (208V \pm 10%).
8. Set Q1 circuit breaker (10) to ON, and check that mains input LED (2) lights on.
9. Check that LED no. 5 (corresponding to the lamp max current) and remote control LED (9) are lit.
10. Close the external ignition switch.
11. Check by means of the voltmeter (13) that there is an output voltage of 130V \pm 10V.
12. Wait 4 seconds max. before striking the lamp.
13. After lamp ignition, it is possible to set the desired output current by means of an external signal 0-10V, following the instructions of the enclosed tables.
14. Check the desired current value by means of the relevant ammeter.

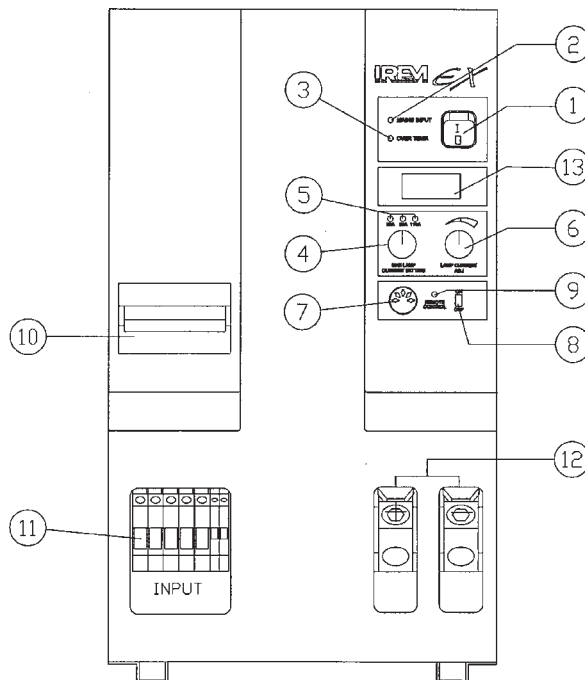

Directions for use

Remote operation

Setting lamp current values by means of 0-10V signal

100A (max. lamp current)

<i>Current (A)</i>	<i>Voltage (DC)</i>
55 ±2	4.55 ±0.1
60 ±2	5.20 ±0.1
65 ±2	5.70 ±0.1
70 ±2	6.20 ±0.1
75 ±2	6.70 ±0.1
80 ±2	7.20 ±0.1
85 ±2	7.60 ±0.1
90 ±2	8.00 ±0.1
95 ±2	8.50 ±0.1
100 ±2	9.00 ±0.1
105 ±2	9.40 ±0.1
110 ±2	10.00 ±0.1

140A (max. lamp current)

<i>Current (A)</i>	<i>Voltage (DC)</i>
55 ±2	3.70 ±0.1
60 ±2	4.10 ±0.1
70 ±2	4.90 ±0.1
80 ±2	5.60 ±0.1
90 ±2	6.40 ±0.1
100 ±2	7.10 ±0.1
110 ±2	7.90 ±0.1
120 ±2	8.60 ±0.1
130 ±2	9.40 ±0.1
140 ±2	10.00 ±0.1

170A (max. lamp current)

<i>Current (A)</i>	<i>Voltage (DC)</i>
65 ±2	3.40 ±0.1
70 ±2	3.80 ±0.1
80 ±2	4.40 ±0.1
90 ±2	5.00 ±0.1
100 ±2	5.70 ±0.1
110 ±2	6.30 ±0.1
120 ±2	6.90 ±0.1
130 ±2	7.50 ±0.1
140 ±2	8.00 ±0.1
150 ±2	8.70 ±0.1
160 ±2	9.30 ±0.1
170 ±2	9.90 ±0.1

Directions for use

Remote operation

Changing the lamp current

To change lamp current (e.g. to switch from a 3000W lamp to a 7000W lamp) when the unit is already on, it is necessary to carry out the following operations.

1. Set the external ignition switch to OFF (open)
2. Set the max. current selector (4) on the new power value and check that the LED no. 5 lights up.
3. Set the external ignition switch to ON (closed).
4. Wait 5 seconds before striking the lamp.
5. Set the desired output current value by means of the 0-10V signal.

Switching off

To switch off the unit:

1. Set the external switch to OFF position (open).
2. Set Q1 circuit breaker (10) to OFF (open).

Remark: if you open the circuit breaker and the lamp is OFF, you have to wait the complete switching off of the power supply (10 s approx.). Then close the circuit breaker again to attempt a new ignition.



The remote functions (switching on/off and lamp current adjustment) can be used all at the same time or alternatively. This means that it is possible to switch on the power supply directly from the control panel and adjust the lamp current from remote and vice versa.

Directions for use

Overheating protection and alarm

EX170-G/3 electronic power supply is equipped with overheating protection and alarm device.

In case of overheating, the unit cuts off the output powering, avoiding possible damages to the circuitry.

In such a condition, the LED "Overtemperature" (3) on the front panel is flashing.

Set S1 switch or the external switch for remote control (according to the operation mode selected) to OFF and set Q1 circuit breaker (10) to OFF.

The thermal protection tripping may be caused by:

1. Too high ambient temperature (max 45°C)
2. Overload in output
3. Insufficient air flow due to obstruction of air slots
4. Failure of the built-in fan/s.

In case of failure, contact **IREM** Servicing Centre.

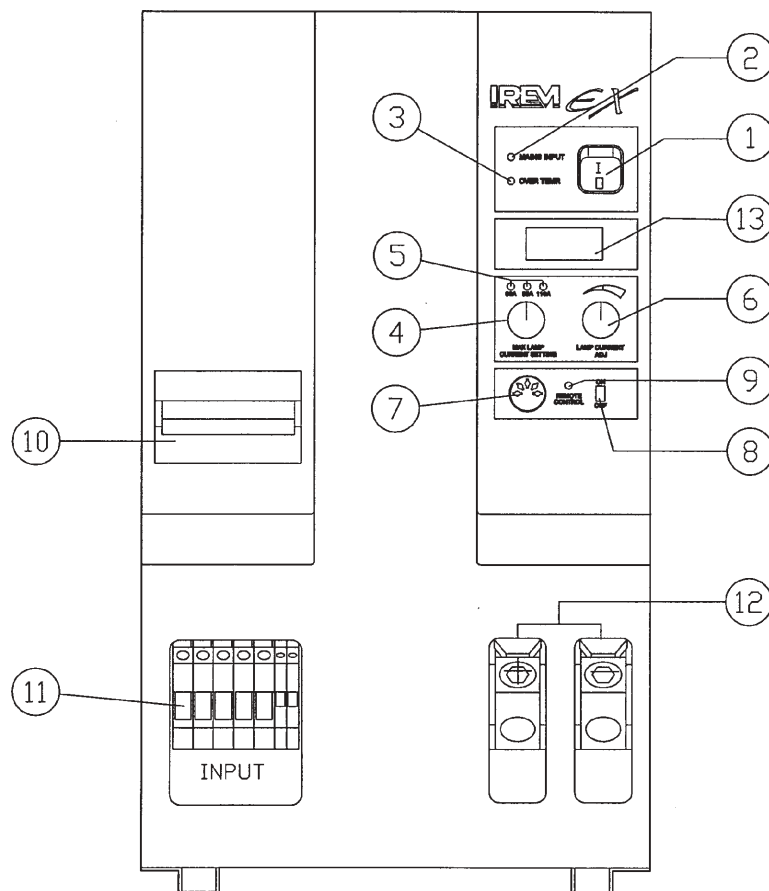

Directions for use

Replacing the fans

In case of fan replacement, please carry out the following steps:

- take off the two screws (1) fixing the fan panel
 - take off the fan panel (2) paying attention not to damage the wiring
 - disconnect the fan (4) from X3 (5) terminal board
 - remove the four fixing screws (3) and take off the fan
- Important note: fan (4) must be correctly placed! The air has to flow from the inside to the outside of the unit.
- fix the new fan to its panel by means of the relevant screws. Connect the fan to X3 terminal board paying attention to the cable polarity.
 - Take in place the fan panel paying attention not to damage the wiring and fix it by means of the two screws (1).

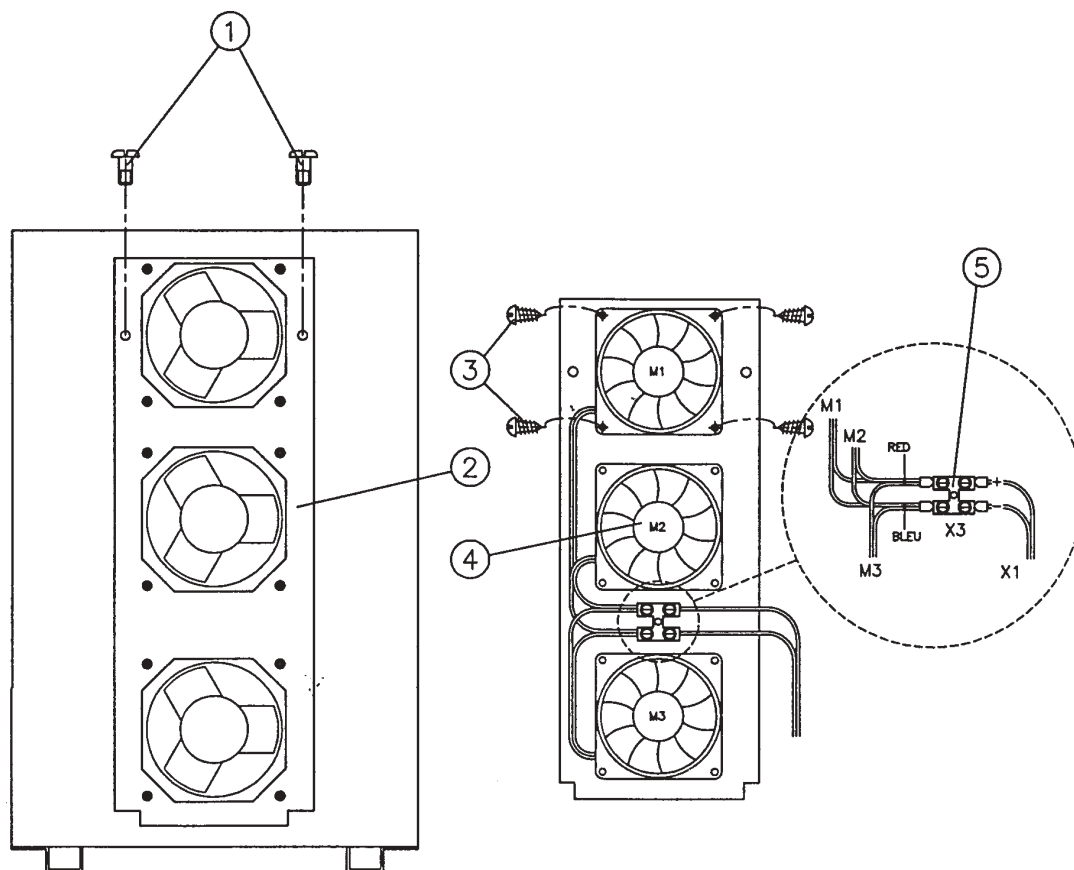

Troubleshooting

Possible failures

Refer to the wiring diagram.



Warning ! Dangerous voltages inside the unit when Q1 circuit breaker (10) is set to ON. Set the circuit breaker to OFF and disconnect the mains powering before attempting any operation inside the electronic power supply. Wait 2 minutes for capacitor discharge.

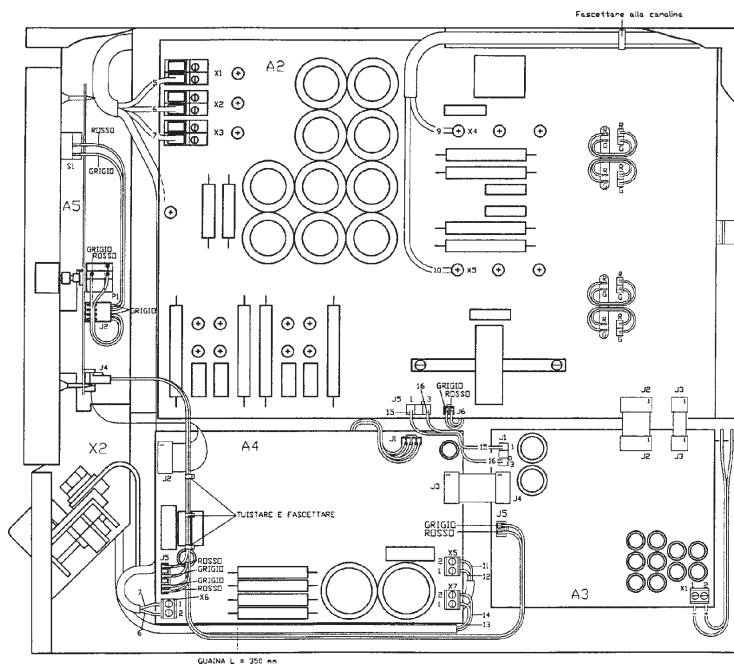
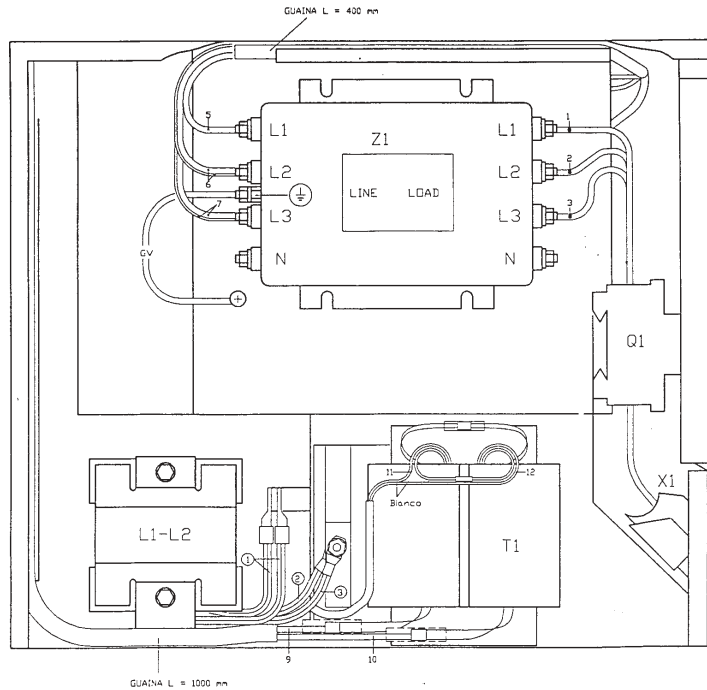

Troubleshooting

Possible failures

1. The power supply does not operate (i.e.: the LED "input mains" is OFF and the fans are not working):
 - . check that the powering voltage is within the unit range (see **EX170-G/3** data plate)
 - . remove the side panels and check that connections, terminal boards and wiring cables are correctly and tightly connected. In case of anomalies make connections again as per wiring diagram.
 - . supply the unit and check:
 - the voltage on A2 board (terminals X1, X2, X3). Value to be found: 208Vac \pm 10%.
 - the voltage on A3 board (connector J1, pins 1 and 3 terminals). Voltage to be found: 295Vdc \pm 10%
 - the lighting up of LED DL1 located on A3 board.

If the previous tests have ascertained some malfunctions, replace A3 board (pay attention to wiring connections and polarity).
2. The power supply is operating, but there is no no-load voltage to the output terminals:
 - . make sure S1 ON/OFF switch is set to 1.
 - . turn off the power supply. Wait 2 minutes for capacitor discharge. Remove the side panels.
 - . check the efficiency of connection of cables 11 and 12 to X3 terminal board (A4 board)
 - . supply the unit. Check the voltage on X3 terminal board (on A4 board). Voltage to be found between terminals 1 and 2: 140Vdc \pm 10%.
 - . check the lighting up of LED DL1 located on A2 board.
 - . if there are no positive results, contact **IREM** servicing centre.
3. The lamp does not ignite
 - . disconnect the power supply. Check the efficiency of lamp clamps.
 - . the lamp has failed: replace it.
 - . set S1 ON/OFF switch to 1. Allow 4 seconds at least before restriking.
 - . check the voltage between output terminals + and - (X2 terminal board) (value to be found: 140Vdc \pm 10%).
 - . no high voltage discharge in the lamp igniter: check the absence of high voltage discharge between the lamp and the metallic body of the lamphouse.
 - . replace the igniter and/or eliminate the discharge failure.
4. The power supply is noisy and the lamp luminous flux is not steady:
 - . be sure that lamp characteristics match the power supply ones.
 - . if the installed lamp has a low power, make sure its output current is \geq 55A. If it is not, turn P1 potentiometer to have this value.
 - . the power supply could be noisy if the powering source is not within the accepted limits.

Troubleshooting

5. The lamp luminous flux is not steady:
 - . check if the lamp current is too low.
 - . if the problem persists, contact **IREM** servicing centre.

6. The lamp turns off during the normal operation:
 - . check the efficiency of the connections.
 - . the lamp has finished its life time. Check its operating time.
 - . the lamp voltage is too low. Check the lamp current.
 - . the intervention of the thermal protection has occurred. This may be due to a too high ambient temperature (45°C max.) and/or to fan failure. Ensure a correct ventilation and/or replace the defective fan.
 - . if any problem arises during fan replacement, contact **IREM** servicing centre.

7. The unit does not operate under remote control conditions:
 - . be sure the DIN plug is well inserted to J1 connector. Make sure the cables are well soldered.
 - . be sure the remote control selector on the front panel is set to ON and that the relevant LED is lit.
 - . **failure on 0÷10V control**: be sure the device connected to the unit supplies a voltage value as per lamp current tables.
 - . **failure on ON/OFF procedure**: check the efficiency of the relevant switch.
 - . disconnect the power supply. Allow 2 minutes for capacitor discharge, then remove the side panels to have access to the internal components.
 - . check the good connection of wires 7 and 8 to X6 terminal board (A4 board).
 - . supply the unit. Check the voltage of X6 terminal board (A4 board). Voltage to be found between poles 1 and 2: 208V \pm 10%.
 - . if the failure persists, contact **IREM** serving centre.

8. The lamp ON signalisation does not operate:
 - . be sure the lamp is ON (min. current: 35A).
 - . be sure that X1 auxiliary terminal cables are correctly and tightly connected.
 - . be sure wires 13 and 14 are tightly connected to X7 terminal board (A4 board).
 - . if the problem persists, contact **IREM** servicing centre.

9. The digital instrumentation does not operate (the unit and the lamp are ON but the digital instrumentation is OFF)
 - . be sure that connectors J4 (A5 board) J5 (A4 board) and J5 (A3 board) are tightly connected. Be also sure that wires are correctly connected to the relevant connectors.
 - . if the problem persists, contact **IREM** servicing centre.

Suggested wiring diagram

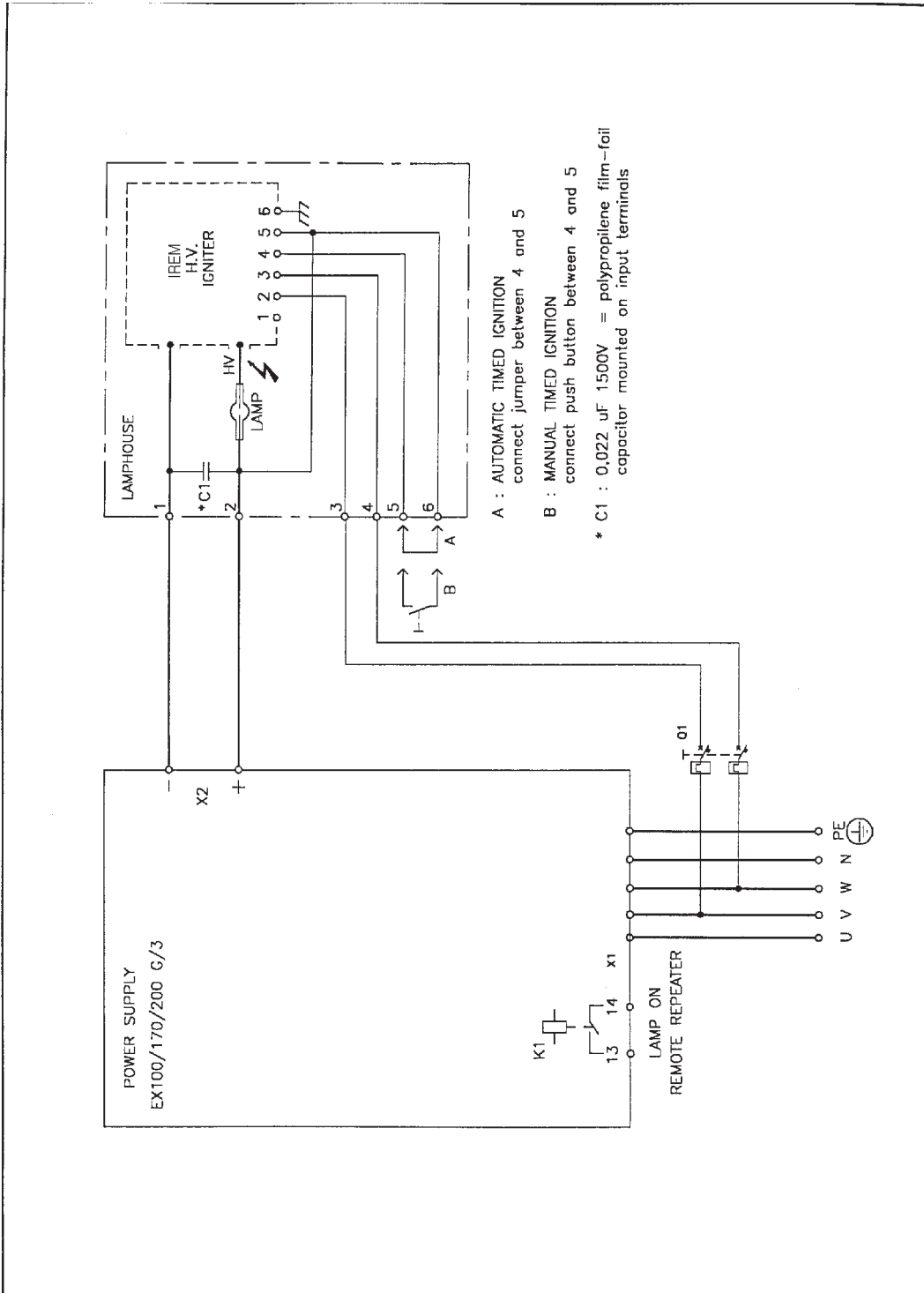

Rev.: 1	Descrizione :	 IREM SpA-S.Antonino (TO) ITALY
Data: 22.6.2000	Power supply EX100/170/200 G/3 208V	
Data: 25.10.1999	Wiring with igniter	
Emesso:		
Approv.:		
Stamp.53 Rev.03 del 08/04/99		N. S35014

EX-170 G/3-US

Overall dimensions

